

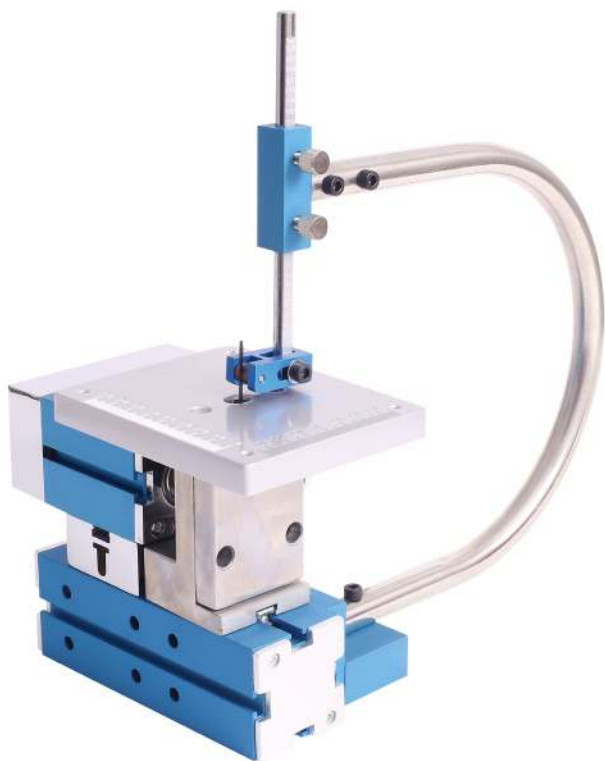

万能金属机床系列说明书

MINI METAL MACHINE
USER MANUAL



W101MEXTA/TB/TC
万能金属锯床加弯管
Jigsaw Machine With Bow Arm

感谢您选购先导万能机床，先导万能机床是针对青少年和模型爱好者设计的一种微型机械加工设备。本产品是一种益智、创客工具类产品。它有助于培养和提高操作者的动手能力、独立思考能力，助力有理想的创客实现自己的想法。

Thank you for choosing XENDOLL multipurpose machines, which are designed for teenagers and DIY hobbyist. It not only helps to cultivate, improve the operational ability and independent thinking, but also inspire operators to achieve their dreams.

致客户/用户 To Customers

为了保障您的安全和健康，请在使用机器前，仔细阅读本说明书。本手册包含机床图解、操作方法、维护清洁、故障排查等，正确的方法会使你的操作更顺畅。

Please read the instruction carefully before using the product. It shows you the whole procedures of operation, maintenance, inspection and cleaning. Further cautions and warning can be found on each machine's operation instruction. Proper operation will make your experience more easier.

安全注意事项 General Caution And Warning

- 保持工作区域干净，不要在脏乱、潮湿的环境下工作。为了您的健康，工作室应通风良好；
Keep the working area clean and dry. Do not work under dirty and wet environment. We highly recommend working in a dust free environment with sufficient airing.
- 少年儿童需在成人陪同下使用；
Children use the machine under supervision of adults.
- 不使用时机器应储存在孩子无法自由取用的地方；
Keep the machine out of reach of children.

- 操作时应佩戴好护目镜，保护您的眼睛；
Always wear goggle to protect your eyes when operating the machine.
- 露在外面的衣服（衣袖）或头发应束好，不可靠近旋转物件，以免卷入弄伤；
Keep your hair and clothing away from the moving parts.
- 机器运转时如有异响应立即停机检查，查明原因并修复后再开机继续使用；
Stop the machine immediately when anomalous sound is heard, use it after the issue was found and fixed.
- 经常检查部件是否有损坏，若有损坏应立即替换或维修被损坏或磨损部分。由于先导机床一些零部件有特殊设计，建议使用原厂零部件，如因使用非原厂零部件而引起不良后果，我司不予负责；
Always check the machine before operation , shift or replace the worn parts if required. As some of the components are designed specially for the machine, you are advised to use our components avoiding injury and to extend the life span of your machine.
- 保持工作室的清洁，油脂、余料及其他杂物需及时清理，工作室不宜储存易燃、易爆及化学用品；
Keep away from chemicals and explosives.
- 本手册不包括全部可能发生的情况和操作，了解常识和小心最安全；
Our manual has not covered all the conditions that you may confront. Please always operates with caution.
- 由于产品升级换代，图片可能与实物有差别，请以实物为准，敬请留意！
Due to irregular upgrading of product, the image/pictures shown in the manual are for reference only.

1. 技术参数 Technical Parameter



More videos on YouTube

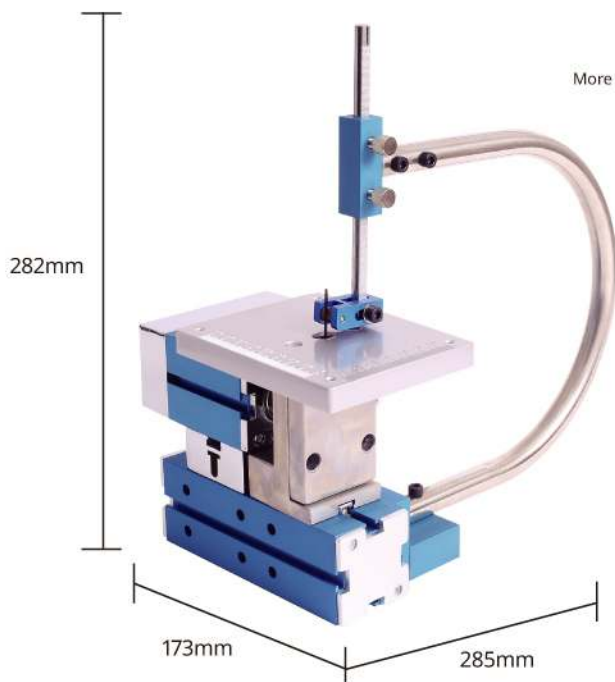

输入电压 Input Voltage	/	AC 100V-240V 50/60HZ
输出电压 Output Voltage	/	DC 12V
电流 Direct Current	/	2A
电机转速 Motor Speed	r/min	20000±15%
主轴转速 Spindle Speed	r/min	3000±15%
锯条行程 Stroke Of Jigsaw Blade	mm	4
工作台尺寸 Working Table	mm	100X120
包装尺寸 Packing Size	mm	200X170X200

2. 部件清单 Part List



W003

主轴箱 Headstock



W015

线锯箱 Jigsaw Case



W018

短机座 Machine Bed, Short



W061

夹头固定螺母 Lock Nut



W004

锯床工作台 Working Table



W021

皮带轮罩 Drive Belt Cover



W093

锯条固定圈 Jigsaw Blade Holder



W064

锯条 Jigsaw Blade



W005

连接块 Connection Pieces



W094

弓形臂 Bow-shape Arm



W025

压板 Platen

3. 随机配件清单 Accessories

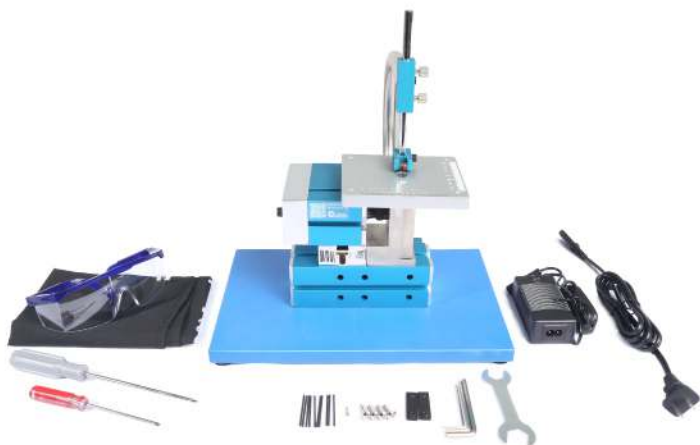

型号 S.N	部件名称 Parts	规格 Spec.
W002	单头开关电源 Power Adapter	12V 2A
W055	薄款双头扳手 Open End Wrench	/
W038	内六角扳手 HEX Wrench	S=2X2
W039	内六角扳手 HEX Wrench	S=2.5X1
W040	内六角扳手 HEX Wrench	S=3X1
W064	锯条 Jigsaw Blade	/
W074	十字盘头不锈钢螺钉 Screw	M2X10
W029	双孔槽螺母 Slot Nut-double Hole	/
W095	十字大扁头机丝螺钉 Screw	M4X16
W057	十字小号螺丝刀 Screwdriver	L=128X3.0
W058	十字中号螺丝刀 Screwdriver	L=190X4.0
W096	围裙 Apron	/
W097	护目镜 Goggle	/

4. 安装图 Installation Diagram

Step 01. 马达主轴箱安装。



Step 02. 整机安装。

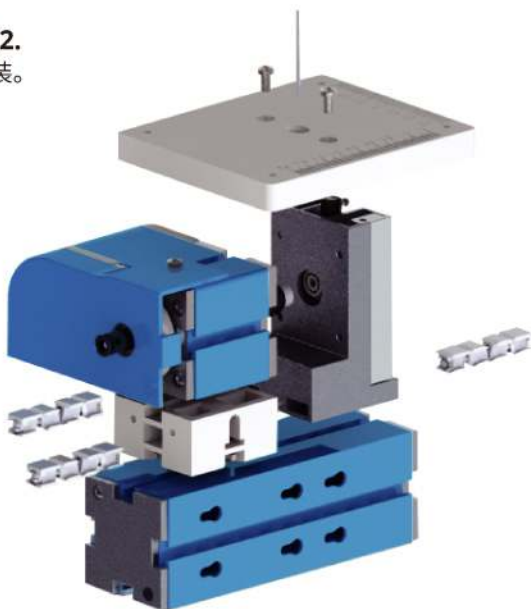

Step 03.
弓形臂安装。



Step 04.
整机安装。



Step 05.
底座安装。

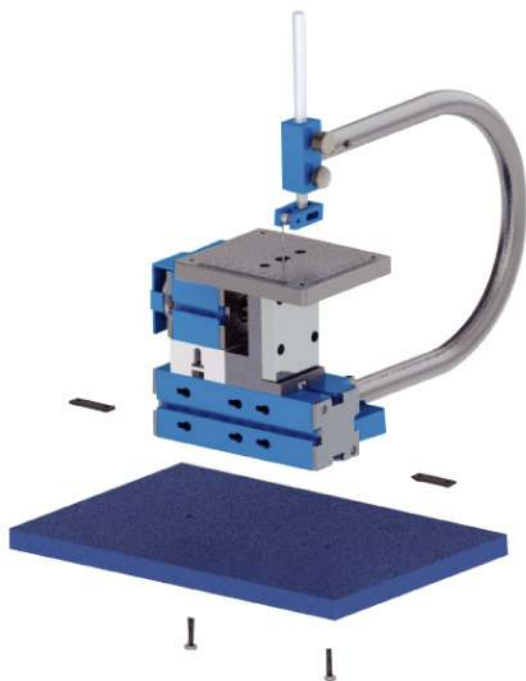

5.使用须知 General Operation Cautions

- 使用机床前，请检查机器零部件是否接触良好，防止运输过程中可能造成部分零件松散。

Please make sure all the parts of machine are tightened before all the operations.

- 使用前，检查主轴箱与线锯箱是否固定，如有松动请紧固(拧紧工字连接块)。

Before using the machine, please check if displacement exists between head-stock and jigsaw case . If it is loosen, please fasten the connection pieces.

- 使用时锯齿朝向操作者，齿尖方向朝下。

When assembling the jigsaw blade, the saw teeth should be facing down.

- 使用时，两手将工件紧压在工作台上向前推进锯切（两手放置在锯条两侧，距离锯条约15mm处）。

Secure the tool and the workpiece. Always keep a firm grip on the tool with both hands.If possible secure the workpiece with a vice or clamps (not included). Keep your both hands 15mm away from the jigsaw blade.

- 加工时出现噪声过大或皮带松脱时，请关闭电源后调整皮带松紧度。

Turn off the machine for driver belt adjustment if the machine is too chatters.

- 加工时，请勿用手触碰旋转部件；避免衣服和头发接触旋转部件；使用时应使用护目镜。

Never touch the rotating parts. Keep hair and loose cloths away from the machine. Always wear goggle while working.

- 使用时，因阻力过大，导致主轴不转或速度明显减慢时，请在三秒内移开阻力或切断电源，以免烧毁电源，查明原因并解决问题，再启动机器。

Cut the power off immediately if the headstock is too hot or stop running.

Please refer to the problem shooting before restart the machine again.

- 锯条卡停时，请断电检查主轴螺母是否锁紧。

If the jigsaw blade is stuck, check whether the lock nut is fastened.

- 本产品经特殊设计，机器不伤手，请放心使用。

Our product is specially-designed , it will not hurt your hands, which can be safely used.

- 使用完毕，先关闭开关，再拔出电源。

Always turn off the machine before unplugging the power cord.

6. 正确的锯割方法 How To Saw Your Workpiece

在锯木板或者其他材料，需要把材料按压在工作台上，调节压板的高度，这样可以利用压板把材料稍微压紧在工作台上，防止工作时材料跳动。压板的位置太高容易压不到木板，太低木板不进去。同时需要调节压块的左右位置，锯条刚好嵌进压板上的滚轮缝隙中。

Before operation, make sure the workpiece has been clamped tightly by adjusting the distance of the working table and the platen in case of any unexpected harm. If the position of platen is too high, is unable to press the workpiece; If it is too low, is unable to put the workpiece inside. At the same time, adjust the position of the pressing block so that the saw blade is just inserted into the gap of the roller of the platen.



当进行锯割进给时，应沿着锯齿方向用力，给予平行于锯齿方向的力度，切割带弧度的形状时，以锯条为圆心旋转材料。

While sawing the workpiece, push it towards the jigsaw with a certain force in a parallel direction. As for the curved shape, centered the jigsaw blade and rotate the workpiece.

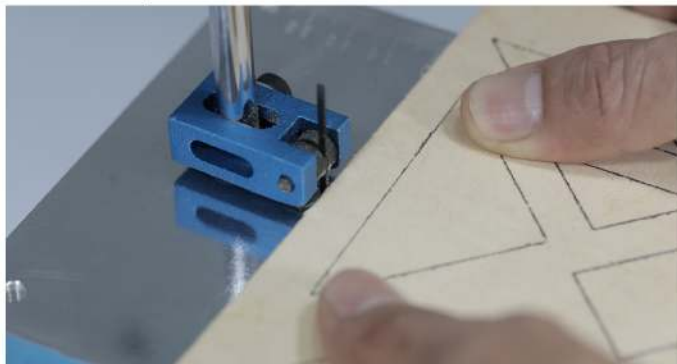

7. 皮带松紧调节方法 How To Adjust The Belt

W101MEXTA系列主轴箱：

用十字螺丝刀调节主轴箱上的皮带调节螺钉，朝顺时针方向拧为拉紧，朝逆时针方向拧为调松皮带。调整螺钉后请将螺钉头朝下压一下以消除螺钉虚位。

Use the Phillips screwdriver to adjust the screw on the headstock. Clockwise tighten and counter clockwise loosen (As shown in the figure).

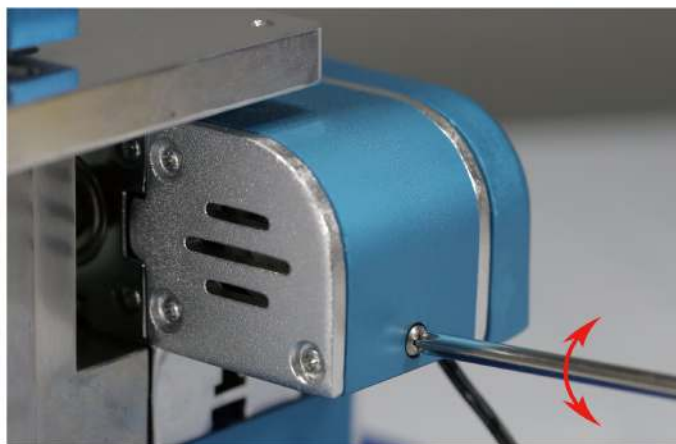

用手压下皮带，皮带压下量为3至5mm时皮带松紧度适宜。

To check the tightness of the drive belt as shown in the figure.



W101MEXTB/TC系列主轴箱:

松开皮带轮罩
Take off the
belt cover



松开固定块上
两个螺丝
Loosen the
screw



调松紧皮带

Adjust the screw on the top, clockwise tighten and counter clockwise loosen
(As shown in the figure).

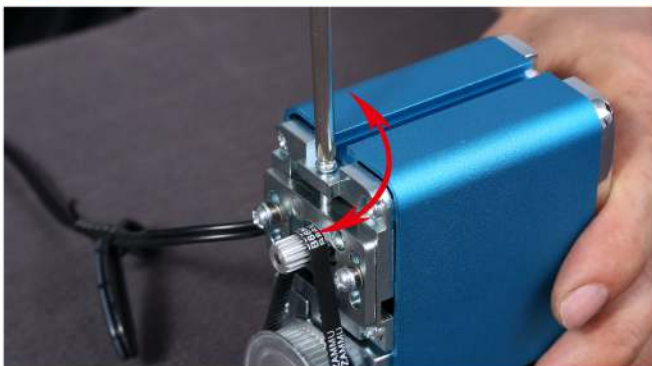

用手压下皮带，皮带压下量为3至5mm时皮带松紧度适宜，然后拧紧电机固定块上的两颗螺丝后把皮带轮罩安装上即可。

To check the tightness of the drive belt as shown in the figure, retighten the screw and put the belt cover on.



8. 更换锯条方法 How To Change The Jigsaw Blade

松开锯条固定圈上的顶紧螺丝，取出旧锯条取出，把新锯条插进线锯箱与固定圈的缝隙中，再拧紧螺丝，注意安装新锯条时锯齿的方向，锯齿的齿尖应该朝下并面向使用者。

Loosen the screw on the retaining ring, remove the blade, make sure nothing remind inside. Place a new blade, the saw teeth should be facing downward and toward the user and tighten it.

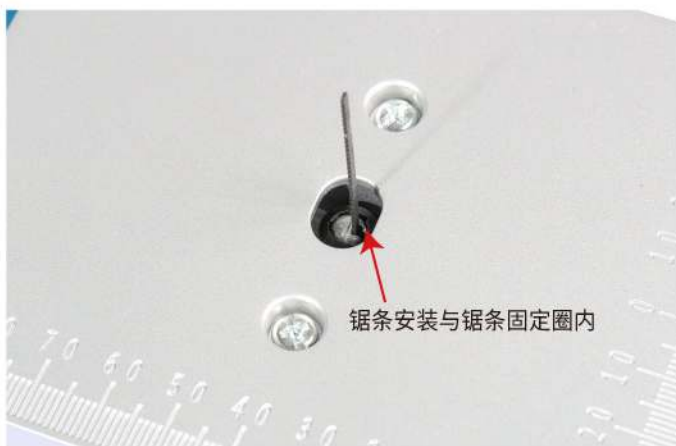

9. 连接块的摆放 How To Assemble The Connection Piece

连接块间相互错开放置（如图所示），螺丝头朝外侧。安装时，连接块的厚截面向上，它的朝向（上下朝向）须朝向需要移动部件一侧。

Put each piece contrary to the others (as shown in the figure), the head of the screw faces outward. Each piece's inclined plane faces inward with the other one.



10. 常见故障处理 Problem Solutions

故障现象 Problems	原因分析 Possible cause	故障现象 Solution
通电后主轴不转 Headstock is not working	电源适配器无输出 Adapter is broken	更换电源 Replace adapter
	主轴卡滞 Spindle is broken	更换主轴轴承 Bearing loosen or worn
	皮带脱开 Driver belt is off the motor	安装皮带并调整松紧 Reload the belt and adjusted
运转噪声过大 Abnormal sounds and noise	各部件连接松动 Loose parts	紧固各部件 Tighten the parts between others
	皮带过松/过紧 The belt is too loose / too tight	调整皮带松紧度 Adjust the tightness of the belt
	无润滑油 Out of lubricating oil	添加润滑油 Add lubricating oil
锯条折断 Jigsaw blade is broken	用力不当 Push too hard	用力不当引致锯条弯曲时应及时调整进给力度 Adjust the strength when seeing the deformation problem of the jigsaw blade
切割不顺畅 Jigsaw cutting hardly	主轴锁紧螺母未锁紧 Lock nut loosen	锁紧主轴锁紧螺母 Tight it up
	锯条正常磨损 Blade blunt	更换锯条 Replace a new blade
	工件在工作台上抖动 Workpiece springs	锯割时工件应压紧在工作台上, 避免工件跟随锯条抖动 Press hard the workpiece on the work table

保修卡

尊敬的用户：

感谢您购买并用本产品，为了使我们的服务让您满意，购买后请认真阅读此保修卡并妥善保存。

一、此保修卡为质保凭证，必须加盖厂家或经销商的印章才有效。

二、免费保修期为一年，自保修卡上注明日期开始计算。

丝杆	轴承	主轴箱
大小滑块	开关电源	长机座
短机座	顶尾座	中间块

质量保证期满后，对设备进行维修，只收取成本费用。最短的时间内完成。

三、下列范围不属于免费保修服务范围：

我们的保修承诺只适用于最初的购买客户，保修期内正常使用情况下所引起的损坏，不包含消耗性的附件或任何由于使用不当、粗心操作、改造引起的损坏。

- 1、超过保修期的机器
- 2、未按产品使用说明的要求使用，维护、保管而造成损坏的。
- 3、自行改装过机器。
- 4、因不可抗力造成损坏的。

四、如何得到服务

当您需要维修服务时，将机床或部件打包退还我司或保修点。同时出示当时的购买凭证。我们会在最短的时间内完成。

相关信息填写表

若您是通过代理商购买产品，请提供该代理商的正确信息，多谢合作！

产品名称： _____ 销售日期： _____

经销商名称： _____ 经销商电话： _____

故障现象： _____

导致原因： _____

用户单位： _____ 姓名： _____ 联系电话： _____

收货地址： _____

Warranty Card

Dear Customer:

Thank you for choosing our products. Please read carefully and keep this warranty card safely.

1. This warranty card must be stamped with seal of the manufacturer or dealer.

2. List of parts under 1 year warranty.

Lead screw	Bearing	Headstock
Slide	Power switch	Machine bed, long
Machine bed, short	Tailstock	Intermediate connection piece

Charges will be applied for repairs and maintenance after expiry date.

3. This warranty excludes and does not cover defect, malfunctions or failures which were caused by repairs by persons not authorized by us, use of parts or accessories not authorized by us, mishandling, improper installation, modifications, or damage to the machine while in your possession, or unreasonable use.

4. Please pack the machine properly with the warranty card and mail it to our after-sale service department.

Customer Registration Form

If you purchased our products through an agent, please provide the information of the agency. Thank you for your cooperation!

Product Model Number / Name: _____

Purchase Date: _____

Name of agency: _____

Phone No. : _____

Malfunction: _____

Customer Name: _____

Customer Phone No. : _____

Customer Address: _____



地址：广东省佛山市顺德区国家高新开发区(容桂高黎)科苑一路3号

电话：0757- 28386038 售后电话：18928655227

邮编：528305

网址：www.xendoll.com 邮箱：info@xendoll.com

Foshan Xendoll Intelligent Technology Co., Ltd.

Address: No.3 Keyuan Road, (Ronggui Gaoli), National High Tech Development Zone,
Shunde District, Foshan City, Guangdong Province, China

Phone: 0757-28386038 Post Code: 528305

Website: www.xendoll.com E-mail: info@xendoll.com



手机版网站



微信公众号



售后服务